

Tank Systems



Tank Systems

are a rugged line of tanks designed to fit most solution handling needs. All tanks are constructed of high density polyethylene (PE) and come in a variety of sizes. An available stand option provides a Stainless Steel Tripod stand with pump mounting shelf for all tank sizes on the Light and Heavy Duty Tanks.

Light Duty Linear Tanks

15 gallon tanks are translucent with 5 gallon increments and feature child resistant black caps. Other tanks have full fitted lids. 30 gallon tanks are HDPE Cream and 40 gallon tanks are HDPE White. 75 gallon tanks are HDPE Black. They feature a integral molded top with a 4 inch diameter opening.

Heavy Duty Tapered Tanks

Tapered PE tanks feature rigid covers which allow the top mounting of Chem-Tech 100, 200 and most PULSAtron pump models. 1/20 HP Flange Mount Mixers may also be mounted on the cover. Tanks available in 35 and 55 gallon capacities are translucent with 5 gallon graduations. (Not suitable for use with 1/3 HP Flange Mount Mixers.)

Industrial Duty Tank Systems

tanks and covers are constructed of high density translucent PE with tank stands constructed of heavy gauge steel with a black corrosion resistant finish. The space conserving base for pump mounting under tank prevents loss of prime by maintaining a flooded suction.

Key Features

Tank sizes from 15 to 200 gallon

High density polyethylene



Industrial Duty Tank Systems come completely piped with PVC bulkhead, ball valve, Y stainer and suction tubing. Tank features graduated increments in both U.S. gallons and liters.

technology
innovation
diversity
excellence

Tank Systems

Specifications & Dimensions

Size Gallon	Wall	Tank Model	Stand Options			Std Model w/ Stand	Std Model w/Hinged Lid	TSR Model	TSR Model w/Hinged Lid	Dimensions (inches)					
			Series 100	Series C, C+, A+ & E*	Series E+ & E (LE33, LE34 & LE44)					Tank Stand	1	A	B	C	D
15	0.078"	40375	39320	J39373	J39378				14.13"	25	14.5				
30	0.094"	J40360	39322	J39374	J39379				18.63"	32	18.5				
40	0.094"	J40361	39323	J39374	J39379				18.63"	41.25	18.5				
75	0.125"	J40362	39324	J39377	J39382				22.63"	41.75	24.25				
35	0.125"	40365	39323	J39375	J39380				18.88"	28	20	23			
55	0.125"	J40366	39321	J39376	J39381				18.13"	42.5	18.5	23			
55	0.13"					40396	J40461	40421	J40455		23	60	17	72	
100	0.25"					40397	J40475	40422	J40448		33	63	17	70	
150	0.31"					40398	J40476	40423	J40477		37	68	17	82	
200	0.31"					40399	J40453	40424	J40436		42	68	17	82	

* Note: All Series E pumps except (LE33, LE34 & LE44)

35 & 55 Gal Lid

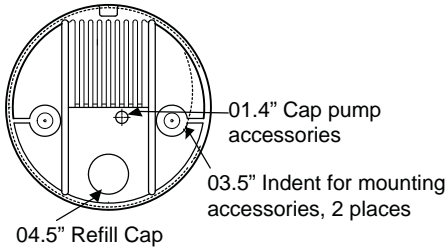

Stand for 15-55 Gal

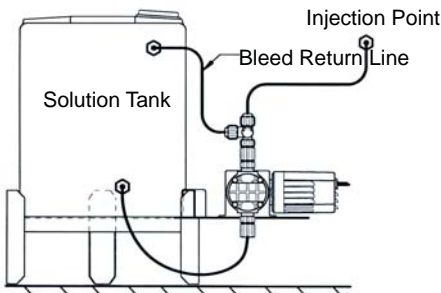
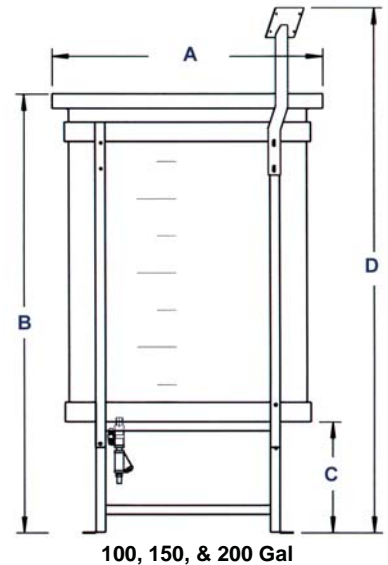
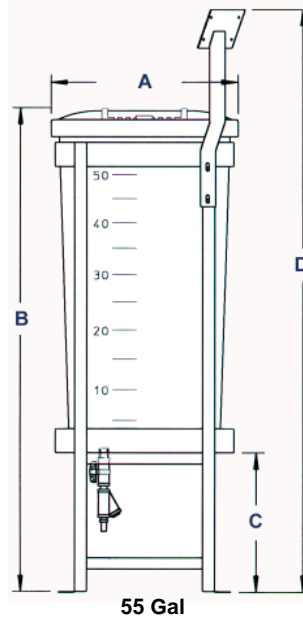
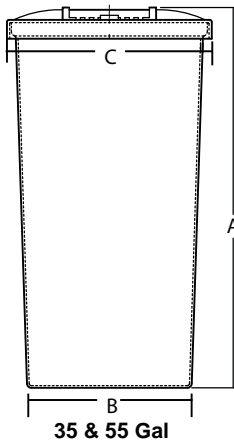
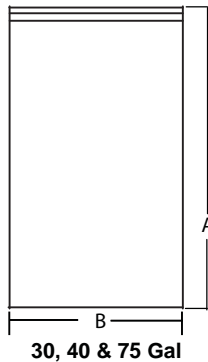
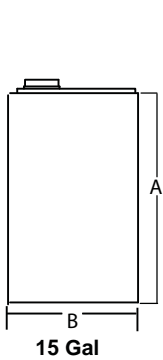
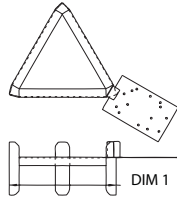

Typical Installations for 15 to 75 Gallon Tank Systems

Typical Tank, Stand, Feeder Combination
(shown with 15 Gallon Tank, Stand, Bulkhead Fittings and Chem-Tech Pump-all components are purchased separately.) Note: When using this type of mount, tank bulkhead fittings are required for the suction and/or return lines. Bulkhead fittings are available in 3/8" O.D. and 1/2" O.D. tubing connections and can be installed at the factory.

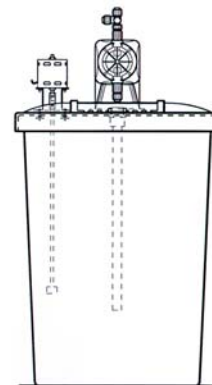

Typical Tank, Mixer, Feeder Combination
(shown with 55 Gallon Tapered PE Tank, 1/20 HP Mixer, PULSAtron Pump and Suction Tube Shield Assembly-all components are purchased separately.)



An ISO Certified Company



A Unit of IDEX Corporation

Standard Product Operations

27101 Airport Road • Punta Gorda, Florida 33982
TEL (941) 575-3800 • TEL 800-333-6677
FAX (941) 575-4085 • FAX 800-456-4085
spottech@pulsa.com • www.pulsa.com